

HAILEA[®]

SINCE 1989

ISO9001:2008 ISO14001:2004

HAILEA HC SERIES CHILLER

INSTRUCTION MANUAL



PATENT NUMBER: ZL200630051337.1/01235915.7

MODEL: **HC-150A**

Before operating this appliance, please read this instruction manual completely and keep it handy for future reference.

CONTENTS



■ PREFACE -----	2
■ SUGGESTIONS FOR SAFE OPERATION -----	2
■ FEATURES -----	3
■ PRODUCTS INTRODUCTION-----	3
■ TECHNOLOGY DATA-----	3
■ PERFORMANCE CURVE -----	4
■ INSTALLATION -----	4-7
1. Please check the contents of the package -----	4
2. Installation place selection-----	5
3. Suggestions for installation-----	6
4. Installation methods -----	6
5. Before starting operation of the unit please check the following points -----	7
■ OPERATION-----	7-8
■ CLEANING AND MAINTENANCE -----	8-9
■ STEPS OF FILTER CLEANING -----	9
■ A GUIDE TO SIMPLE PROBLEMS SOLVING -----	10
■ PARTS LIST -----	11
■ GUARANTEE CLAUSES -----	11
■ CIRCUIT DIAGRAM-----	12

HAILEA HC SERIES CHILLER

PREFACE

Thanks a lot for purchasing a Hailea HC series chiller, the chiller represents a significant step forward in aquarium cooler engineering, offering state of the art technology at highly competitive prices. Temperatures in aquaria ranging from 50 to 6000 litres (from 12 to 1500 gallons) can now be quickly and economically maintained by selecting the correct model from the chillers in the Hailea HC range and, with a heat exchanger that is manufactured from high grade pure titanium, the chillers are suitable for applications in fresh or salt water aquariums. The super silent design results in significantly lower noise levels. quieter than any other similar domestic or foreign refrigerator, whilst the digital temperature controller ensures that the selected temperature is maintained. Hailea HC series chillers have strong chassis with a housing of ABS plastic which is anti-rust, anti-corrosive, ensuring the chiller does not look out of place in any surroundings and as with other cooling units, our chillers use the environmental friendly refrigerant R134a. For the complete use and understanding of this chiller, it is recommended that this instruction manual is thoroughly read and understood. Failure to do so may result in loss of fish or damage to this unit.

SUGGESTIONS FOR SAFE OPERATION

Several symbols are used in this manual and on the product itself which are aimed at proper and safe operation in order to prevent you from injury or others or damage to the chiller. The meanings of these symbols are explained below. Please make sure you understand their meanings before you read this manual.

EXPRESSIONS (TERMS AND SYMBOLS)

Hazard seriousness level will be indicated by the term or shown by pictures. The symbol on the left is a general emphasis but specific details of the action which must be taken will be shown by a picture or explanatory near to the symbol.



This symbol advises you of an item which should be noted (including danger and warning).



This term indicates the possibility that continuing working while ignoring this attention, or working incorrectly without full understanding, may cause personal injury or equipment damage.



This symbol advises you of an action which must be taken (is mandatory) in order to avoid danger.



This symbol advises you of an action which must not be taken (is prohibited) in order to avoid danger.

HAILEA HC SERIES CHILLER

FEATURES

1. Microcomputer control system for the convenience of user.
2. Large refrigeration capacity, aquarium water can be refrigerated to any degree above 4°C in a short period of time.
3. Adopt Freon-free R134a refrigerant, which is safe and environment friendly.
4. The super quality condenser is manufactured by American OAK production line.
5. Anti corrosive pure titanium evaporator for fresh & sea water dual use.
6. Auto overcurrent power off protection system.
7. Temperature memory system that makes the chiller refrigerate continuously according to the previous temperature when the power supplied again to protect fish in the aquarium.

PRODUCT INTRODUCTION

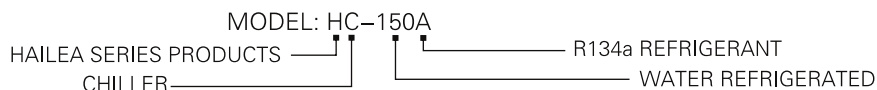

TECHNOLOGY DATA

Model	HC-150A
Rated Voltage	220-240V (110-120V)
Rated Frequency	50Hz (60Hz)
Working Current	1.1A (2.2A)
Power	1/10HP
Water Temperature Before Refrigeration	28°C
Refrigeration Time	20h
Water Temperature After Refrigeration (Water Refrigerated 150L)	16°C
Water Temperature After Refrigeration (Water Refrigerated 300L)	22°C
Refrigerant	R134a
Refrigerant Weight	180-200g
Rate of Flow	250-1200L/h
Weight	15Kg
Size	420x248x365mm

1. The rate of flow is decided according to the max jet of the pump (immersible pump or other external power filter) and the circulation equipment.
2. The refrigeration performance test is indicated when the ambient temperature is 30°C, the water temperature before refrigeration is 28°C, the setting temperature is 16°C and the water refrigerated is 150/300L. When water refrigerated reduces, the water temperature will drop down on.
3. The refrigeration efficiency is determined according to the installation location, heating source, lighting, pump filter and other connecting parts. Special pump and other accessories sold with Hailea series chillers should be used. Do not use other alternatives to avoid affecting the performance of the unit.
4. When there is not enough exchange air in a room, the refrigeration efficiency is reduced if the surrounding temperature increases due to the heat from the unit.

HAILEA HC SERIES CHILLER

PERFORMANCE CURVE

MODEL: HC – 150A AMBIENT TEMPERATURE: 30°C WATER_REFRIGERATED: 150L

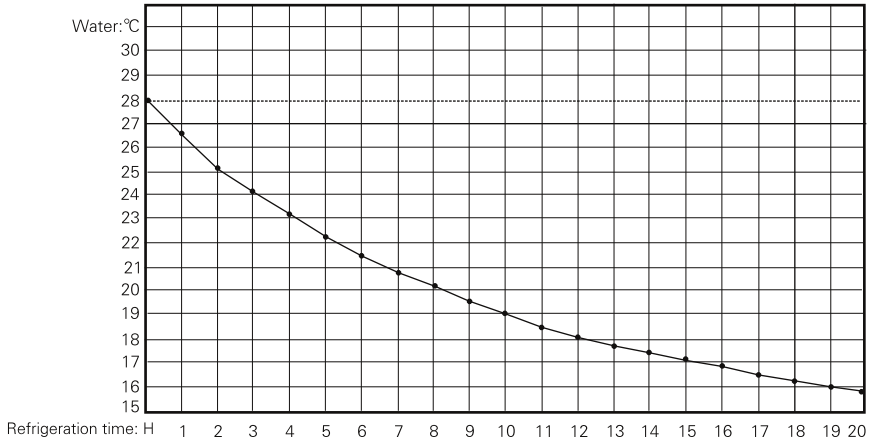

The refrigeration performance test is indicated when the ambient temperature is 30°C, the water temperature before refrigeration is 28°C, and the water refrigerated is 150L . When water refrigerated reduces, the water temperature will drop down to any degree above 4°C in a short period of time.

INSTALLATION

When the chiller carton is unpacked, check to see that the chiller is the right model and that no damage to the chiller occurred during the transportation. You also check to be certain that the quantity and quality of the spare parts and accessories are the same as those mentioned in the instruction manual. If you find out any discrepancy or difficulties, please enquire to our dealer in your area.

1. PLEASE CHECK THE CONTENTS OF THE PACKAGE:

- ※ HAILEA HC Series chiller1 set.
- ※ Instruction manual1 piece.

OPTIONAL :

- ※ Water inlet & outlet adaptor4 pieces.
- ※ Nut4 pieces.

HAILEA HC SERIES CHILLER

※ Seal rubber ring.....4 pieces.

※ Fuse(in the socket)1 piece.

2. INSTALLATION PLACE SELECTION :

- (1) Don't install the chiller outdoors. (Fig.1)
- (2) Place the chiller in a ventilated place away from inflammables, high temperature, direct sunshine, moisture or dust.(Fig.2)
- (3) Place the unit on a horizontal stable surface. (Fig.3)
- (4) Install at least 20~40 cm away from the walls or other things for venting . (Fig.4)
- (5) Don't cover the chiller, while it's working avoids shaking or colliding with other things directly.
- (6) The circulation water flow of the chiller is indicated in the technology parameter table. This chiller doesn't have a water pump. So, it needs a pump with an external filter available. The lift is no more than 8m maximum. If other equipment out of specification is used, it may cause water leak or other damage. (Fig.6)
- (7) Do not put the unit up side down; it will cause damage to the unit. If it is put side down due to draining water or other reason for a short period of time, put it straight and wait for 20 minutes before switching it on. (Fig.7)

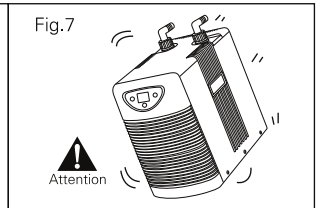
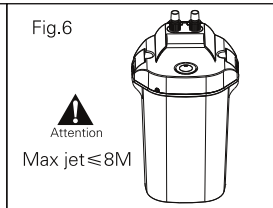
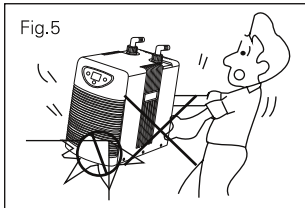
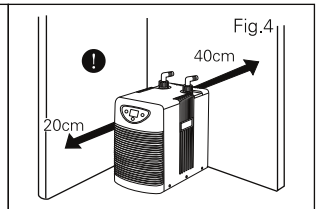
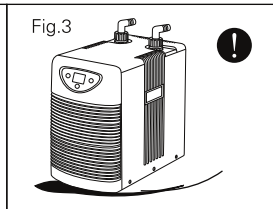
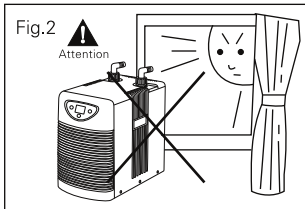

HAILEA HC SERIES CHILLER

3. SUGGESTION FOR INSTALLATION :

1. Electrical work must be done by a qualified electrician.
2. Provide a separate power outlet to be used only for the unit.
3. Ensure that the power source to be utilized conforms to the power requirements specified on the product nameplate.
4. The power supply should be fitted with earth leakage breaker.
5. Disconnect the power during installation.

4. INSTALLATION METHODS

Note: The chiller must be operated with circulation & filtration system. The chiller also can be installed in a hidden position such as inside an closed style aquarium cabinet. But if your cabinet has no ventilation grilles, they must be made. When the grilles are being made, make sure the air intake grilles must be in exact alignment with the aspiration grille of the chiller and the air outlet grille on the cabinet should be made as high as possible for easy air outlet. The chiller should be installed with its back as near as possible to the grille of the cabinet to allow for fresh air circulation. The chiller also can be installed under an open style aquarium cabinet. As you know, it should be installed at a minimum distance of at least 20–50 cm from each side of the cabinet, so as to allow a fresh flow air in the intake area. For fresh air circulation, it is suggested to put your chiller out of the aquarium cabinet. If the chiller is placed under a water fish tank fitted with a filter, a water intake tube must be provided with the water pump which arrives directly to the input connector on the chiller to ensure the intake water is pure. For sea water, it must be filtered before arriving the chiller, or the evaporator will be dirty and this will affect the refrigeration. Please note that the filter (with the pump) must be located below the aquarium water level.

If you wish to place the unit at the side of the aquarium, you must fill the filtration system with water before turning it on.

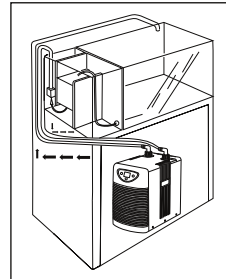
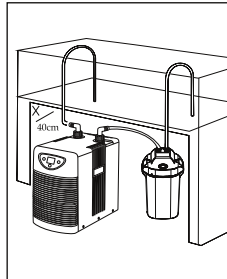
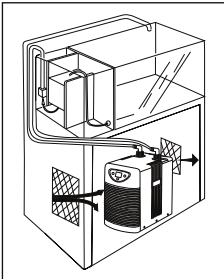

HAILEA HC SERIES CHILLER

5] BEFORE STARTING THE OPERATION OF THE CHILLER , PLEASE CHECK THE FOLLOWING POINTS:

- (1) Check if the water level inside the aquarium is appropriate.
- (2) Make sure that no water leakage from the hose connections.
- (3) Insert the power plug with its full contact into the power outlet so that the plug itself does not wobble.
- (4) Make sure there is nothing wrong with the water circulation & filtration system, especially the circulating tube must not be clogged.

OPERATION

Note: Before starting the chiller, you must run the pump & make sure that there is nothing wrong with the water circulating system. There are three buttons for switching or setting temperature on the control & command panel (operation panel).

■ AQUARIUM TEMPERATURE DISPLAY & SETTING TEMPERATURE DISPLAY

Press the (SET) button for a short period of time, the aquarium water temperature and the set temperature will appear alternatively on the panel. Temperature indicator turns off to indicate the aquarium water temperature. When the indicator twinkles, it indicates the set temperature.

■ ADJUST THE SET TEMPERATURE

Press the (SET) button for more than three seconds to indicate that the programming function is enabled and the previously setting temperature value will appear on the display, press the "△" button for increasing temperature or "▽" button for decreasing temperature to choose your required temperature. The setting temperature is from 4°C to 28°C. After setting, press the (SET) button again or just waiting for eight seconds. The aquarium water temperature will appear on the display while the chiller is working.

■ TEMPERATURE ERROR ADJUSTMENT (□□)

The common setting is "□□", when the aquarium water temperature is different from the temperature value which appears on the display of the chiller, you can adjust the error as following:

Press "△" and "▽" buttons at the same time for 6 seconds till the display twinkles, then press "△" or "▽" button separately for temperature error adjustment ranging from -1.5°C to +1.5°C. (Do not use this function frequently if it is not necessary.)

■ THE CHILLER PROTECTION DEVICE TO BE RESPONDING

Protection device is provided with the chiller. The refrigeration compressor needs three minutes to start after resetting and for the first time, it needs about one minute.

HAILEA HC SERIES CHILLER

■ REFRIGERATION COMPRESSOR ON & OFF AUTOMATICALLY

When the refrigeration compressor stops working for over three minutes & the water temperature is 1°C above the set temperature, the compressor will start to work again automatically. The compressor will stop working automatically when the aquarium water temperature reaches or is below the set temperature. Working state indicator on the panel turns on to indicate that the compressor is working, turns off to indicate the aquarium water temperature reaches the set temperature and the compressor stops working; the indicator twinkles to show that the protection device is responding for three minutes.

■ AUTOMATIC BREAKDOWN DISPLAY SYSTEM

Automatic breakdown display system is also provided with the chiller. When the water temperature sensor has open circuit or has broken circuit, the letters "P1" or "P2" will appear on the display and the protection device will be responding to stop the chiller.

CELSIUS OPERATION PANEL

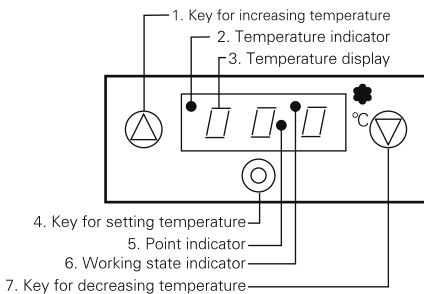

FAHRENHEIT OPERATION PANEL

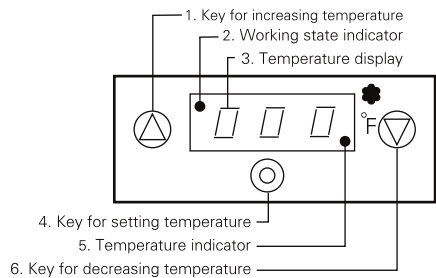

CLEANING AND MAINTENANCE

1. Cleaning of the circulating system and the filtration system is recommended once a month or once two months for optimum refrigeration performance operation and efficiency, unplug the cord from the outlet before cleaning.
Rinse collected debris from the filter media, inlet & outlet pipe, flow diverter, impeller and chamber cover with clear lukewarm tap water. Soap or detergents are not recommended for filter maintenance because they are bad for the fish's health. (Fig.1)
2. Remove the dust at the air inlet and outlet with a brush or a vacuum cleaner. To avoid electric shock, during operation, do not insert wire into the exhaust outlet or the air inlet. (Fig.2)
3. The plug electric supply switch and temperature adjuster must be cleaned with dry soft cloth. (Fig.3)
4. Don't immerse the unit into water or flush it with water directly to avoid damage the electric insulation of the chiller. (Fig.4)

HAILEA HC SERIES CHILLER

5. Disconnect the power supply plug if the unit will not be used for a long time, remove the inlet & outlet pipes, then lift the back of the chiller a bit to remove water inside the chiller, clean all the parts with a soft cloth and cover it with a vinyl bag, put it into the color box , then store it in a safe and dry place. (Fig.5)
6. If the supply cord is damaged, it must be replaced by the manufacturer or its service agent or a similarly qualified person in order to avoid a hazard.
7. If you still have any other questions, please contact with our dealer or an Authorized Service Center near your home. (Fig.6)

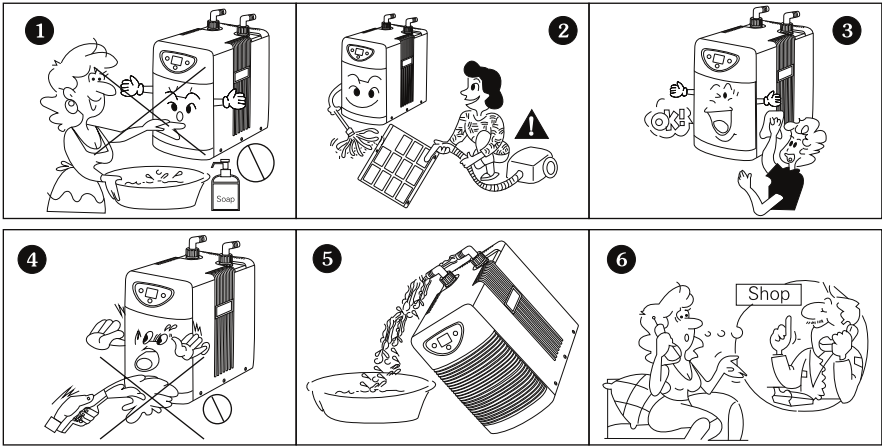

STEPS OF FILTER CLEANING

1. Draw front drawl hood out lightly by hands (Fig.1)
2. Loosening screws of the filter (Fig.2).
3. Remove the filter (Fig.3).
4. Remove the dust with a brush or a vacuum cleaning completely (Fig.4).
5. Install all the parts back by counter steps.

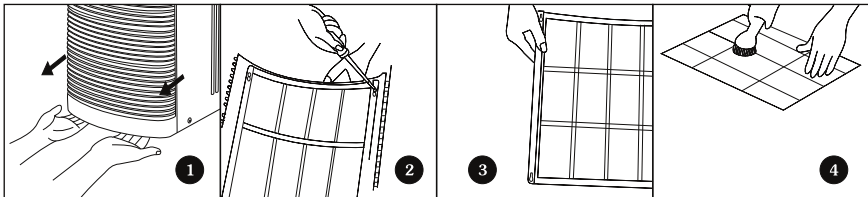

HAILEA HC SERIES CHILLER

A GUIDE TO SOLVE SIMPLE PROBLEMS

Before calling service personnel, please check the following chart for possible cause to the trouble you are experiencing.

SYMPTOM	CAUSE	COUNTERMEASURE
No power source. The unit doesn't run & the display appears nothing	Power is not turned on	Turn on the power
	Plugged in insufficiently	Be sure the power cord is fully plugged in
	The fuse has broken	Change a new one
The unit repeats on and off	Apply to wrong voltage and frequency	Apply to correct power source according to the nameplate
	The unit protection device to be responding	A. Check if the water circulation is normal B. If the fan and the chiller dissi- pate heat normally, wait for 3 minutes & the unit will turn on again automatically
Water refrigerated reduces or even no refrigeration	The compressor runs normally, the fan stops running, the unit can't dissipate heat	Replace with a new fan of the same specs
	The set temperature is higher than the aquarium water temperature	Reset refrigerate temperature
	The air inlet and outlet are clogged with dirt	Remove the dust at the air inlet/outlet with a brush or a vacuum cleaner
	Refrigerant is not enough	 Look at page 3, fill the unit with the same type of refrigerant by a qualified electrician
	Too much water in aquarium	Reduce the water
Running with shock & loud noise	The base is not flat	Mount it on a flat base

HAILEA HC SERIES CHILLER

PARTS LIST

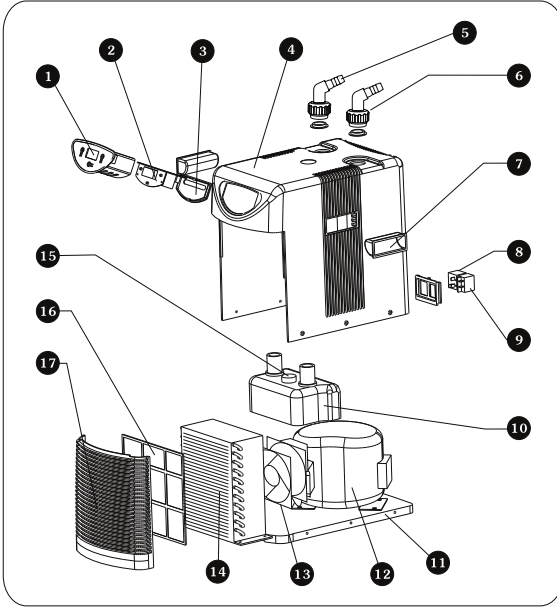

- ❶ Control & Command box
- ❷ Circuit board
- ❸ Back cover of circuit board
- ❹ Top cover
- ❺ Water inlet & outlet adaptor
- ❻ Nut ❼ Handle Ⓢ Switch
- ❾ Socket
- ❿ Tank(with evaporator)
- ⓫ Base ⓬ Compressor
- ⓭ Fan motor ⓮ Condenser
- ⓯ Water temperature sensor
- ⓰ Filter (Front draft hood)
- ⓱ Front draft hood

CIRCUIT DIAGRAM

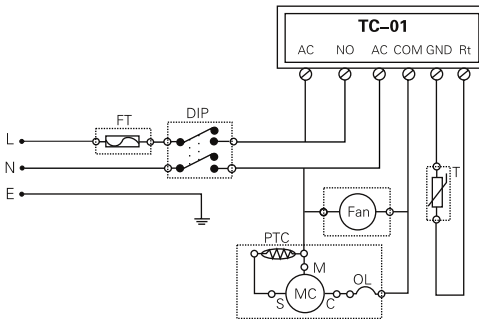

- TC-01 Temperature controller
- FT Fuse
- PTC Motor starter
- Fan Fan
- MC Compressor
- OL Motor protector
- T Water temperature sensor

HAILEA HC SERIES CHILLER

GUARANTEE CLAUSES

The GUANGDONG HAILEA CO., LTD. hereby agrees to take the responsibility of servicing the HAILEA HC series chiller identified on this guarantee form.

■ SERVICE UNDER GUARANTEE

1. This product is guaranteed by us against defects due to faulty workmanship or materials.
2. If the product has been damaged under normal use, it will be entitled to be free repairing service. Service under guarantee is provided only upon presentation of reasonable evidence (eg. Compelted guarantee card or purchase receipt) that date of the claim is within the guarantee period.

■ **GUARANTEE PERIOD** : A period of ONE YEAR after the date of purchase.

■ SERVICE NOT UNDER GUARANTEE

1. The guarantee is not valid if the defect is due to accidental damage, misuse or neglect and in case of alterations or repair carried out by unauthorized persons.
2. If your unit can't work after guarantee or during guarantee because of your using or maintaining uncurrantly , we'll charge the material cost.
3. If your guarantee form is missing, the guarantee is not valid, either.



ONE YEAR WARRANTY

WARRANTY FORM

DATE :

PURCHASER'S NAME		TELEPHONE NUMBER	
POST CODE		PRODUCT	
ADDRESS			
MODEL		PRODUCT NUMBER	
TO BE SIGNED AND SEALED BY THE RETAILER			
WITH EFFECTIVE FROM (DATE OF PURCHASE)			
REPAIRING SUMMARY RECORD			

Guangdong
Hailea Group Co.,Ltd
Factory Address: Sinli Industrial Zone, Sinli Road,
Raoping County,Guangdong Province,515700,China
Tel: +86-768-8888888 Fax: +86-768-8883813
www.hailea.com E-mail: info@hailea.com

Hailea Group Co.,Ltd
Guangzhou Oversea Sales Branch
24/F, East Tower, Twin City International Plaza, No.
263, Huasui Road, Zhujiang New Town, Guangzhou
City, Guangdong Province, 510623,China
Tel: +86-20-3837 2888 Fax: +86-20-3837 2791